



**DuraTherm**  
Insulated Sectional Garage Door

Great to come home to!



Up to  
**10**  
Year Warranty



# Welcome Home! Contents...

Aside from the excellent style choices and its built to last quality, DuraTherm is the high performance garage door - take a look at some key features before you get to know us a little better!



**Why choose a DuraTherm?**

Page 3



**The DuraTherm 45**

Pages 4 - 19



**DuraTherm Side Doors**

Page 19



**DuraTherm Wicket Doors**

Pages 19



**The DuraTherm 70**

Pages 20 - 25



**Liftmaster Automation**

Pages 26 - 27



**Technical Information**

Pages 28 - 31

Great to come home to!



# Why choose a DuraTherm sectional garage doors?



Made in Germany!



## Quality & durability of DuraTherm surfaces

All sectional garage doors and sectional garage side doors with coated (Trend Colour or RAL of your choice), wood effect (Golden oak, Dark oak, Winchester and Night oak) and Satingrain Black are top coated. As well as giving your garage an elegant look, our quality surfaces are more resistant to environmental factors, so you can enjoy your garage door for longer.



## Premium quality backed up by our warranty

DuraTherm sectional garage doors bear the Garage Door Systems seal of quality. All our garage doors and operators comply with iso 9001 and the safety requirements of European garage door standard EN 13241. Steel doors come with a ten-year guarantee on functional safety and against rusting through from the inside out. There is a five year warranty on Trend, Custom RAL, Wood Effect and satingrain black finishes.



## Insulation and energy efficiency

The PUR rigid foam insulation ensures that DuraTherm sectional garage doors have excellent heat insulation. Low power consumption is assured by our energy-saving drives, which consume only 0.8 watts in stand-by mode, and by our equally efficient add-ons.



## Upgrade your garage door with an automatic system

Whether you have a brick or concrete garage, as DuraTherm renovation doors are designed to match the most common old door sizes, they can easily replace many doors without the need to convert the garage opening or order a special design. If the new sectional door is installed behind the garage opening, the passage width increases. Virtually any door can be automated.



## The worlds No.1, LiftMaster

As a leading provider of convenience and security products for homes & businesses worldwide, LiftMaster's strong foundation emanates from the millions of products manufactured and sold since the early 1960s. Around the world, there are more LiftMaster openers installed than any other brand.

# Key Features of DuraTherm 45

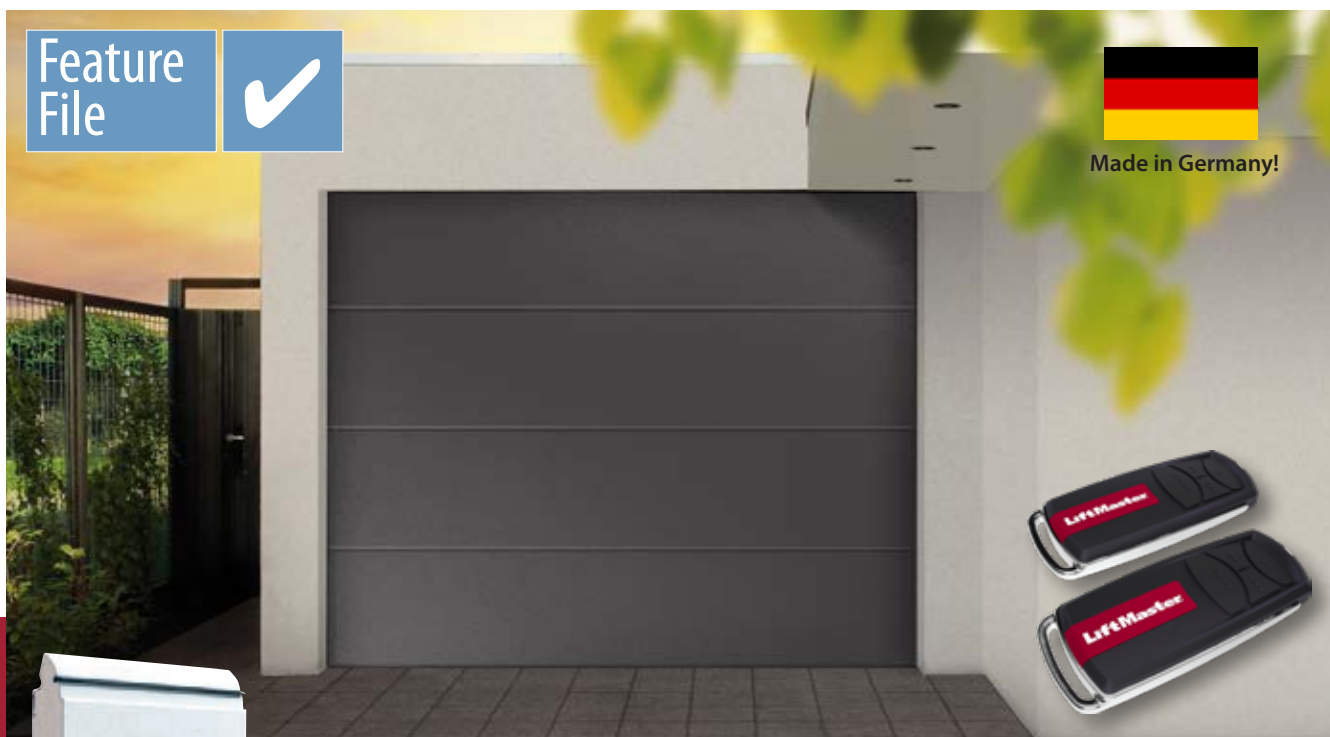

Feature  
File



Made in Germany!



45 mm

DuraTherm 45 is filled with a 45 mm rigid foam core, which provides maximum heat insulation and top soundproofing values.

- Ideal for private garage sizes ranging from 2,250 to 5,500 mm.
- Widest range of models and equipment:
  - Individual design garage door.
  - With side door or integrated pass door of the same design.
- Smooth running, superbly durable and stable, thanks to a sturdy design that is extremely distortion-resistant.
- Spring technology either with a vertical tension spring system or with stable torsion spring shafts.
- Perfect functional reliability and easy operation with torsion spring with spring break safety feature on both sides.
- Maximum personal safety with anti-pinch feature inside and out (as per EN 12604).
- Maximum heat insulation with 45 mm rigid PUR foam core (heat insulation value  $U = 0.55 \text{ W/m}^2\text{K}$ ).
- Inside door leaf: Polyester based primer, grey white, similar to RAL 9002.
- Outside door leaf (standard): Traffic white, similar to RAL 9016 (prime coated).
- Vast choice of colours, wood effect finishes and textures. Please see details by model on the following pages.



Our DuraTherm 45 sectional garage doors are available either with a vertical tension spring system or with stable torsion spring shafts with a maintenance-free spring fracture safety device that is tested to EN 12604.



Control your garage door from your phone with the No.1 in the world, LiftMaster!

See the full details on **page 26 - 27!**



## DuraTherm 45 Door Patterns

---



S-Rib

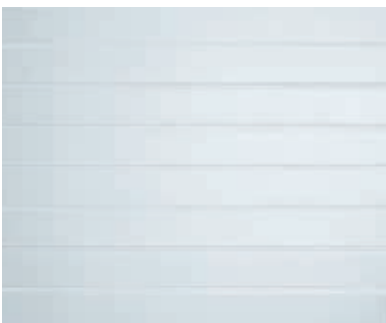

M-Rib

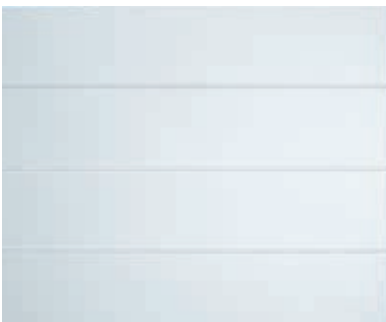

L-Rib



Georgian



# 1 THERMAL INSULATION

## SANDWICH PANEL

- External steel sheet
- Internal steel sheet
- Foamed polyurethane

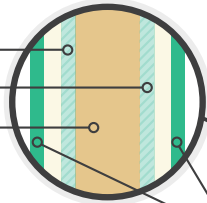

DuraTherm sandwich panels are 45mm & 70mm thick.

## THERMAL INSULATION OF DURATHERM DOORS PANEL CORRESPONDS TO THE FOLLOWING MATERIALS

45mm = 620 mm

70mm = 960mm



DuraTherm 45



Wall made from bricks

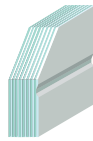

DuraTherm 70

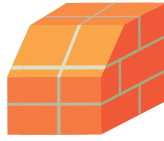

Wall made from bricks

## THERMAL TRANSMITTANCE OF DURATHERM PANEL

**DuraTherm 45  $U = 0.55 \text{ W}/(\text{m}^2\text{K})$**

**DuraTherm 70  $U = 0.34 \text{ W}/(\text{m}^2\text{K})$**

# 2 SOUND INSULATION

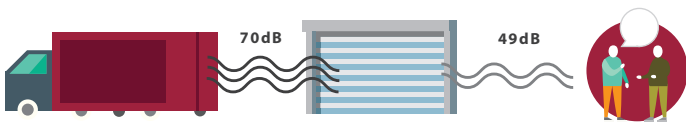

# 3 RELIABLE COATING

## RESISTANCE TO CORROSION

Zinc coating 12 microns thick and double layer polyurethane coating (20–30 microns) on the panel outer surface which is modified with polyamide particles (PUR-PA) which protects the sandwich panels from scratches and cuts caused by mechanical action and the effects of the elements.



# DURATHERM SECTIONAL

## 7 MAIN AD



# 4 COMFORT

## DURABILITY

**15 000**

open/close cycles

## AUTOMATIC

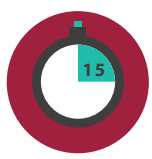

Allows opening doors within **15 seconds**.

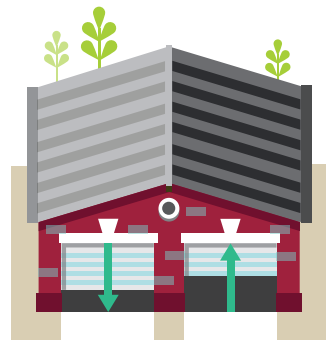

which is equal to

**14 YEARS**

of operation with 3 open/close cycles per day



## IT IS KNOWN

The number of rainy days in Britain is 195.

# GARAGE DOORS



Made in Germany!

## VANTAGES



### 5 RESISTANCE TO WIND LOADS

Doors withstand wind speed up to 90 km/h.



### 6 EXCELLENT DESIGN

#### DIFFERENT PANEL PATTERNS

To suit all decorative styles.

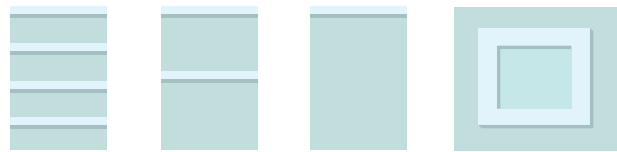

S

M

L

Georgian

ribbed panel

ribbed panel

ribbed panel

#### COLOUR RANGE

Great range of standard colours

Can be finished in all RAL colours

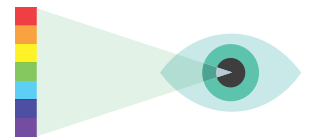

Wood effects - availability varies by model



### 7 SAFETY

Correspond to European standards EN 12604 and EN 12453.

#### PROTECTION AGAINST DOOR LEAF FALLING

1 m<sup>2</sup> of door leaf weighs approximately 15 kg. Weight of medium size DuraTherm door of (7 m<sup>2</sup>) — is more than 100 kg.

The door leaf is safely balanced with springs that do not move independently. A special device protects against spring break and the door leaf falling.



#### DOOR LEAF STOPS IF THERE IS AN OBSTACLE



#### PROTECTINO AGAINST FINGER TRAPPING

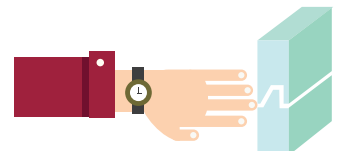

Sandwich panel design protects against finger trapping.

#### OPERATION



Allows operating doors without leaving the car.



Thus you will get wet 195 times less!

#### VERTICAL OPENING

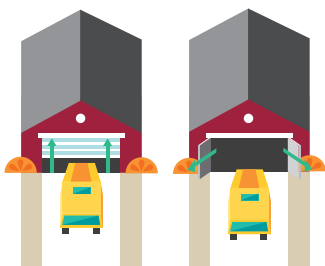

Saving space in front of the garage.



Don't have to clear snow in front of the garage.

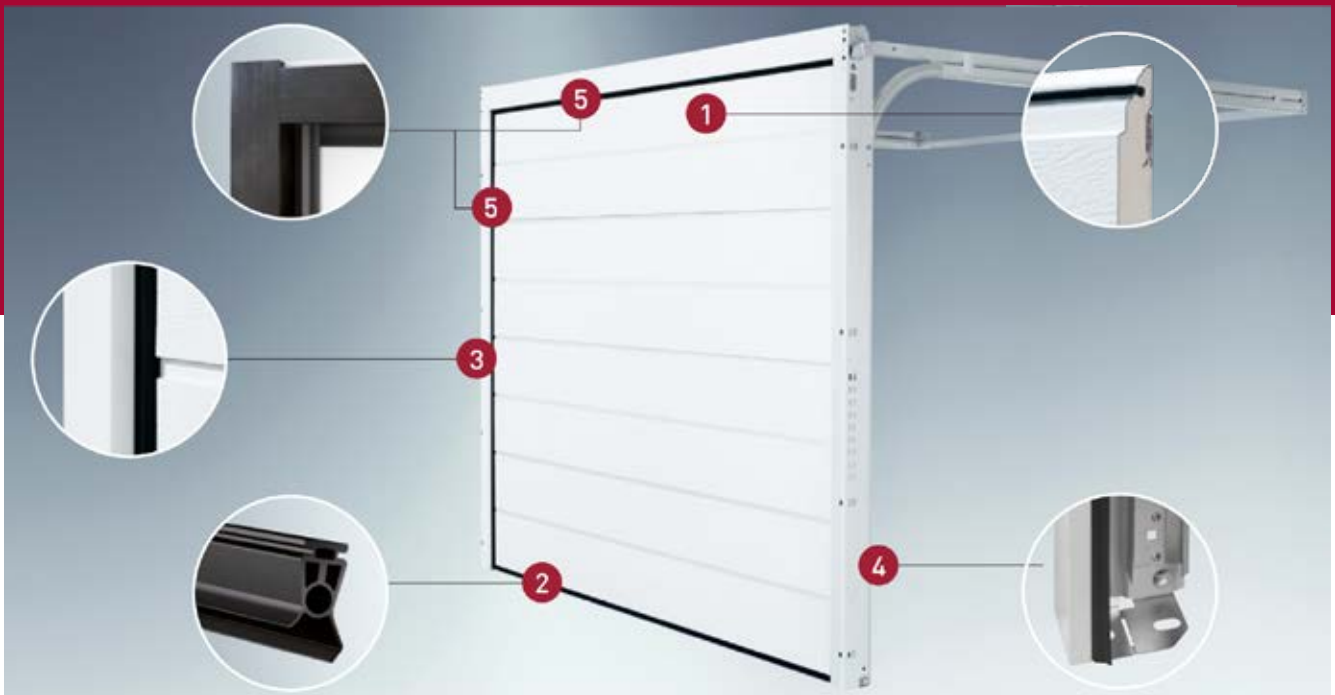

## 1 Double skinned & insulated

DuraTherm's steel sections are manufactured in a double-skinned sandwich construction with an insulating PUR rigid foam core. This means that they have better sound and heat insulation than single-skinned doors, together with very quiet door operation. The flexible lip seals between the sections fit closely even at low temperatures. They help prevent heat losses and help keep the dust out.

## 2 Frost-resistant floor seal

A rubber profile on the bottom edge of the garage door helps protect from water and dirt, evens out very slight floor unevenness and prevents damage and injuries. The floor seal is made of high-quality EPDM (ethylene propylene diene monomer), which is known for its high elasticity, weather resistance and durability.

## 3 Lip seals on the frame

Extra wide for better heat insulation and protection against dirt.

## 4 Adaptable frame base

DuraTherm sectional garage doors are fitted with a weatherproof frame base made of galvanized steel. So water and accumulated moisture can drain off freely and the frame will not start to rust, even after long periods. The stepped design is ideal for renovation projects that involve the installation of a sectional garage door to replace an up-and-over door with floor track.

## 5 Optional thermo frame set

The optional Thermo frame set improves the performance of the entire building. It can be used on all DuraTherm sectional garage doors and enhances their already excellent properties. The frame is insulated on three sides and improves insulation performance by up to 15 %\* when mounted behind the opening. Its plug-and-clip profile makes it quick and easy to install.

**\* This performance is dependent on the door pattern and size.**

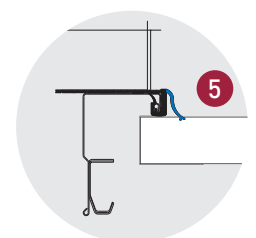
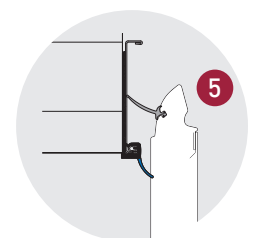



# Inside DuraTherm 45

\* Illustration relates to DuraTherm 45 sectional garage door.

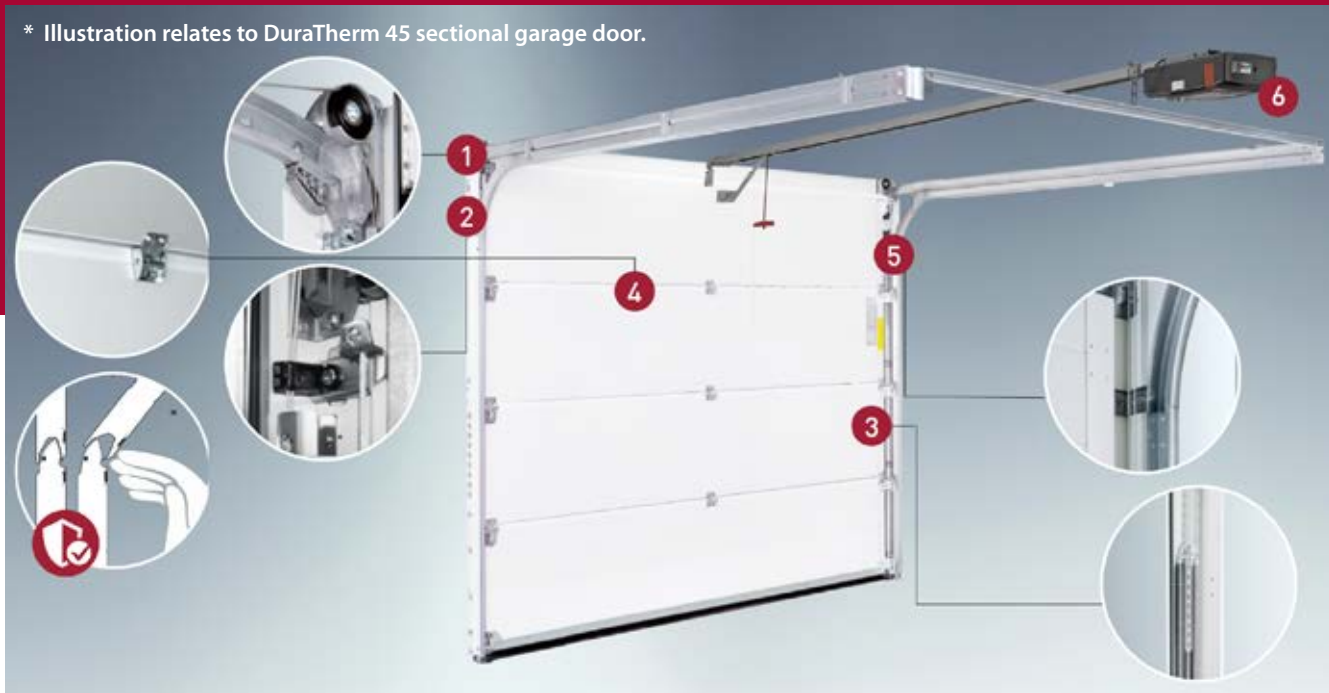

The DuraTherm 45 sectional garage doors with widths of up to 3,000 mm and a height of 2,500 mm (smooth) or 2,750 mm (Woodgrain) come with a vertical tension spring system.

With DuraTherm 70, this is possible up to a width of 3,000 mm and a height of 2,375 mm. With a rebate width of just 80 mm per side, these garage doors are also ideal for renovations.

## 1 Interference-protection deflection pulley

The steel cables run vertically into the angular frame on interference-protected deflection pulleys mounted on ball bearings with U-shaped roller holders. This reduces the height requirement compared to a front-mounted torsion spring.

## 5 Interference protection and cables channelled down the inside

The angular frames make it almost impossible to reach between the door leaf and the frame. Suspension cables arranged inside minimize the risk of injury and guarantee maximum operational reliability.

## 2 Cable mount

Together with the steel cable holder, the newly designed cable mount keeps the steel cables running smoothly in the angular frame without them touching the insulated sections. The separate door guide ensures optimum closure of the door.

## 6 The No.1 Operator

All doors are available with LiftMaster® openers - **see details on pages 26 - 27.**

## 3 Multiple tension spring assemblies

For doors with tension springs: The springs are adjusted the top end of the spring assembly. Vertical tension springs make smaller installation depths possible and take up little room.

## Torsion springs for DuraTherm 45

All springs are computer calibrated for your exact door size. Smaller doors are equipped with compact tension springs and larger doors are supplied with torsion springs.



## 4 Anti-pinch inside and out

The design of the sections and hinges prevents pinching on the door leaf - from inside and out.

Both variants provide smooth, reliable operation of your door.

# DuraTherm 45 L-Rib (Smooth)



**DuraTherm 45 L-Rib  
Smooth in Golden Oak**



**DuraTherm 45 L-Rib  
Smooth in White (Similar to  
RAL 9016) with square porthole  
windows with stainless steel frame**



**DuraTherm 45 L-Rib  
Smooth in Anthracite Grey  
(Similar to RAL 7016)**

# Surfaces Finishes, Colours & Door Patterns

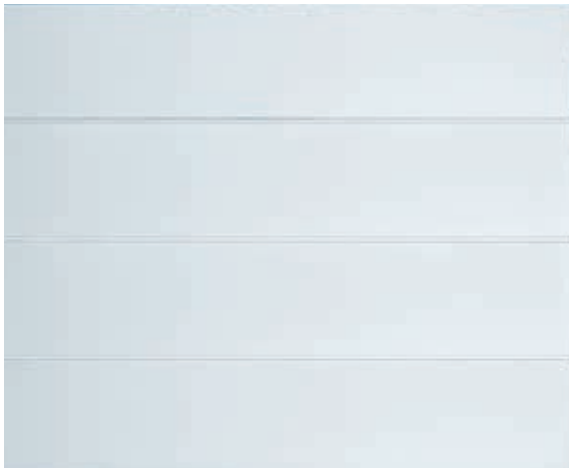

## Surface Finish

Smooth

The elegant smooth surface which repels dust & moisture.

Woodgrain

Also available in Woodgrain! See pages 14 - 15 for colour options.

## Standard Colour

Traffic White

Similar to RAL 9016



For window & handle options, see **page 18!**

## Trend Colours:

|                       |                        |                     |                     |                     |                        |
|-----------------------|------------------------|---------------------|---------------------|---------------------|------------------------|
| <b>Steel Blue</b>     | <b>Moss Green</b>      | <b>Fir Green</b>    | <b>Light Grey</b>   | <b>Window Grey</b>  | <b>White Aluminium</b> |
| Similar to RAL 5011   | Similar to RAL 6005    | Similar to RAL 6009 | Similar to RAL 7035 | Similar to RAL 7040 | Similar to RAL 9006    |
| <b>Grey Aluminium</b> | <b>Anthracite Grey</b> | <b>Ochre Brown</b>  | <b>Nut Brown</b>    | <b>Sepia Brown</b>  |                        |
| Similar to RAL 9007   | Similar to RAL 7016    | Similar to RAL 8001 | Similar to RAL 8011 | Similar to RAL 8014 |                        |

## RAL Colours

Can't find the colour you want?  
The DuraTherm 45 is also available in ANY Classic (4-digit) RAL for a modest price.

## Wood Effects:

|                   |                 |                   |                  |
|-------------------|-----------------|-------------------|------------------|
| <b>Golden Oak</b> | <b>Dark Oak</b> | <b>Winchester</b> | <b>Night Oak</b> |
|-------------------|-----------------|-------------------|------------------|

## Satingrain Surface Finish:



(Composite shade)

Extremely weather resistant top coating, only for DuraTherm 45 garage doors.

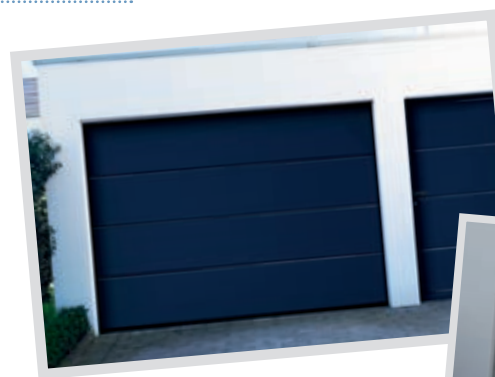

**DuraTherm 45 L-Rib Smooth in Steel Blue**  
(Similar to RAL 5011)



**DuraTherm 45 L-Rib Smooth in Grey Aluminium**  
(Similar to RAL 9007)

Colours shown are for guide purposes only and are limited by the printing process. Always request to see a finish sample for confirmation of colour.

RAL numbers are provided as the nearest approximation to the colour and will not match precisely.

# DuraTherm 45 M-Rib (Smooth)



DuraTherm 45 M-Rib  
Smooth in Grey Aluminium  
(Similar to RAL 9007)



DuraTherm 45 M-Rib  
Smooth in Golden Oak



DuraTherm 45 M-Rib  
Smooth in Anthracite Grey  
(Similar to RAL 7016)

# Surfaces Finishes, Colours & Door Patterns

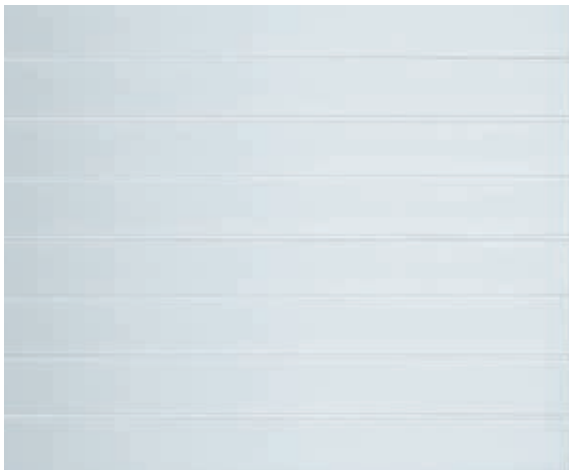

## Surface Finish

Smooth

The elegant smooth surface which repels dust & moisture.

Woodgrain

Also available in Woodgrain! See **pages 14 - 15** for colour options.

## Standard Colour

Traffic White

Similar to RAL 9016



For window & handle options, see **page 18!**

## Trend Colours:

|                       |                        |                     |                     |                     |                        |
|-----------------------|------------------------|---------------------|---------------------|---------------------|------------------------|
| <b>Steel Blue</b>     | <b>Moss Green</b>      | <b>Fir Green</b>    | <b>Light Grey</b>   | <b>Window Grey</b>  | <b>White Aluminium</b> |
| Similar to RAL 5011   | Similar to RAL 6005    | Similar to RAL 6009 | Similar to RAL 7035 | Similar to RAL 7040 | Similar to RAL 9006    |
| <b>Grey Aluminium</b> | <b>Anthracite Grey</b> | <b>Ochre Brown</b>  | <b>Nut Brown</b>    | <b>Sepia Brown</b>  |                        |
| Similar to RAL 9007   | Similar to RAL 7016    | Similar to RAL 8001 | Similar to RAL 8011 | Similar to RAL 8014 |                        |

## RAL Colours

Can't find the colour you want?  
The DuraTherm 45 is also available in ANY Classic (4-digit) RAL for a modest price.

## Wood Effects:

|                   |                 |                   |                  |
|-------------------|-----------------|-------------------|------------------|
| <b>Golden Oak</b> | <b>Dark Oak</b> | <b>Winchester</b> | <b>Night Oak</b> |
|-------------------|-----------------|-------------------|------------------|

## Satingrain Surface Finish:



(Composite shade)

Extremely weather resistant top coating, only for DuraTherm 45 garage doors.



DuraTherm 45 M-Rib Smooth in Golden Oak



DuraTherm 45 M-Rib Smooth in Grey Aluminium (Similar to RAL 9007)

Colours shown are for guide purposes only and are limited by the printing process. Always request to see a finish sample for confirmation of colour.

RAL numbers are provided as the nearest approximation to the colour and will not match precisely.

# DuraTherm 45 S-M-L-Rib (Woodgrain)



DuraTherm 45 S-Rib  
Woodgrain in Anthracite Grey  
(Similar to RAL 7016)

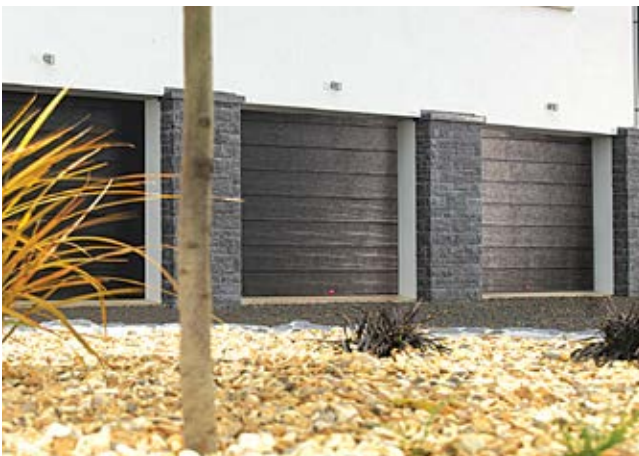

DuraTherm 45 M-Rib  
Woodgrain in Black  
(Similar to RAL 9005)



DuraTherm 45 S-Rib  
Woodgrain in Custom RAL  
Colour Cream

# Surfaces Finishes, Colours & Door Patterns



## Surface Finish

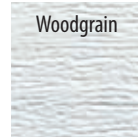

The robust classic design with a subtly grained wood texture.

## Standard Colour



Similar to RAL 9016



For window & handle options, see **page 18!**

## Trend Colours:

|                       |                        |                     |                     |                     |                        |
|-----------------------|------------------------|---------------------|---------------------|---------------------|------------------------|
| <b>Steel Blue</b>     | <b>Moss Green</b>      | <b>Fir Green</b>    | <b>Light Grey</b>   | <b>Window Grey</b>  | <b>White Aluminium</b> |
| Similar to RAL 5011   | Similar to RAL 6005    | Similar to RAL 6009 | Similar to RAL 7035 | Similar to RAL 7040 | Similar to RAL 9006    |
| <b>Grey Aluminium</b> | <b>Anthracite Grey</b> | <b>Ochre Brown</b>  | <b>Nut Brown</b>    | <b>Sepia Brown</b>  | <b>Black</b>           |
| Similar to RAL 9007   | Similar to RAL 7016    | Similar to RAL 8001 | Similar to RAL 8011 | Similar to RAL 8014 | Similar to RAL 9005    |

## RAL Colours



Can't find the colour you want?  
The DuraTherm 45 is also available in ANY Classic (4-digit) RAL for a modest price.

Colours shown are for guide purposes only and are limited by the printing process. Always request to see a finish sample for confirmation of colour.

RAL numbers are provided as the nearest approximation to the colour and will not match precisely.



**DuraTherm 45 S-Rib Woodgrain in White**  
(Similar to RAL 9016)



**DuraTherm 45 S-Rib Woodgrain in Grey Aluminium**  
(Similar to RAL 9007)

# DuraTherm 45 Georgian (Woodgrain)



DuraTherm 45 Georgian  
Woodgrain in White  
(Similar to RAL 9016)



DuraTherm 45 Georgian  
Woodgrain in Golden Oak



DuraTherm 45 Georgian  
Woodgrain in White  
(Similar to RAL 9016)



# Surfaces Finishes, Colours & Door Patterns



## Surface Finish

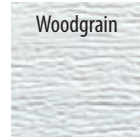

The robust classic design with a subtly grained wood texture.

## Standard Colour



Traffic White

Similar to RAL 9016



For window & handle options, see **page 18!**

## Trend Colours:

|                       |                        |                     |                     |                     |                        |
|-----------------------|------------------------|---------------------|---------------------|---------------------|------------------------|
| <b>Steel Blue</b>     | <b>Moss Green</b>      | <b>Fir Green</b>    | <b>Light Grey</b>   | <b>Window Grey</b>  | <b>White Aluminium</b> |
| Similar to RAL 5011   | Similar to RAL 6005    | Similar to RAL 6009 | Similar to RAL 7035 | Similar to RAL 7040 | Similar to RAL 9006    |
| <b>Grey Aluminium</b> | <b>Anthracite Grey</b> | <b>Ochre Brown</b>  | <b>Nut Brown</b>    | <b>Sepia Brown</b>  | <b>Black</b>           |
| Similar to RAL 9007   | Similar to RAL 7016    | Similar to RAL 8001 | Similar to RAL 8011 | Similar to RAL 8014 | Similar to RAL 9005    |

## RAL Colours



Can't find the colour you want?  
The DuraTherm 45 is also available in ANY Classic (4-digit) RAL for a modest price.

## Wood Effects (smooth):

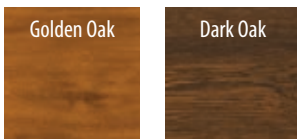

Colours shown are for guide purposes only and are limited by the printing process. Always request to see a finish sample for confirmation of colour.

RAL numbers are provided as the nearest approximation to the colour and will not match precisely.



DuraTherm 45 Georgian Woodgrain in Custom RAL Colour Cream

DuraTherm 45 Georgian Woodgrain in Fir Green (Similar to RAL 6009)



## Windows



Standard Window

Cross Bar Pattern

Rhombus Pattern

Dimensions:

- Inside: approx. 392 x 192 mm
- Outside: approx. 460 x 260 mm

Window details:

- S-Rib, M-Rib and L-Rib: 25 mm acrylic double glazing, clear or crystal.
- Georgian: 20 mm double acrylic glazing, clear or crystal.
- Available in White and RAL colours.



## Porthole windows Available with clear or crystal glazing.



Porthole with stainless steel frame, 10 mm acrylic double glazing\*

Dimensions:

- Inside: approx.  $\varnothing$  290 mm
- Outside: approx.  $\varnothing$  350 mm

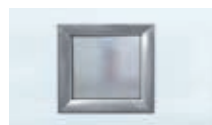

Window with stainless steel frame

Dimensions:

- Inside: approx. 235 x 235 mm
- Outside: approx. 320 x 320 mm



\* Only for M-Rib and L-Rib garage door patterns.

## Full vision



Pane thickness 16 mm



Acrylic glass with crystal structure



Acrylic double glazing



Available in White and most RAL colours.

Note: Wood effect and satina finishes are combined with windows in a suitably toning shade.

## Door handles



Optional lock handle for manual doors only is formed from a sturdy black polymer and supplied with a smooth operating Euro cylinder.

# DuraTherm 45 Single Leaf & Wicket Door Patterns



## Single leaf side doors



S-Rib



L-Rib



M-Rib



Georgian

## Wicket doors



S-Rib



L-Rib



M-Rib



Georgian

Note: The aluminium profiles of side-hinged doors, side doors and wicket-door frame profiles with wood effect and satigrain finishes are finished in a suitably toning shade.

# DuraTherm 70 Premium Plus Door



New premium sectional doors with industry-leading insulation and security at a surprisingly affordable price!



With the new DuraTherm Premium Plus sectional garage door, your garage is protected against wind and weather. The exceptionally good insulation helps to ensure that your garage, with a living area next to it or above it, does not cool down too much, even in winter. This way you avoid heat loss and actively contribute to optimising the entire building's performance balance.

Are you looking for maximum energy efficiency and the greatest possible safety and security in addition to premium quality and the utmost ease of use? Then choose premium sectional garage doors with a total section thickness of 70 mm.

DuraTherm 70mm

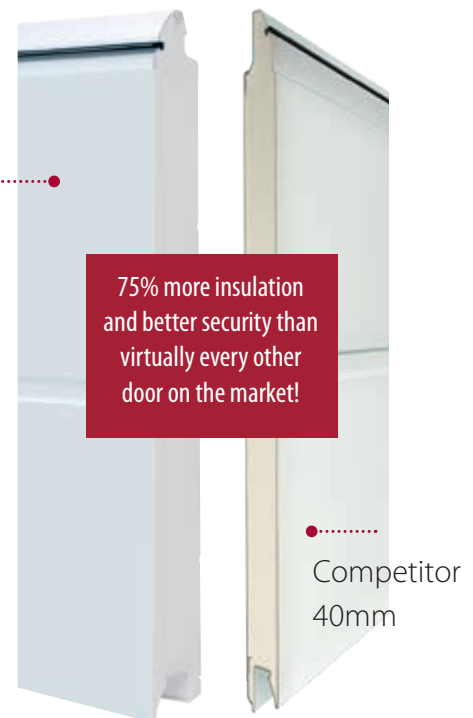

Competitor 40mm

## Features:

- Selection of modern designs in a wide range of colour options.
- Uniform appearance of inside of door, with smooth surface and coordinating details (hinges, profiles, etc.) coloured to match the door leaf.
- Maximum personal safety with anti-pinch protection inside and out.
- Smooth door travel thanks to stainless steel ball-bearing tandem rollers and extremely quiet garage door operators.

# Discover the benefits to you

Feature  
File



## Exceptionally good thermal & acoustic insulation

The patented thermally broken sections with a total thickness of 70 mm, combined with the sectional door's PUR rigid foam core, ensure exceptionally good heat and sound insulation. The additional seals between the sections and the double floor seal on the bottom of the door further increase the heat insulation and reduce heat losses.



## Optional Triple-glazed windows

Our Premium Plus sectional garage doors are also available with triple-glazed window variants that provide not only excellent heat insulation but also outstanding light permeability.

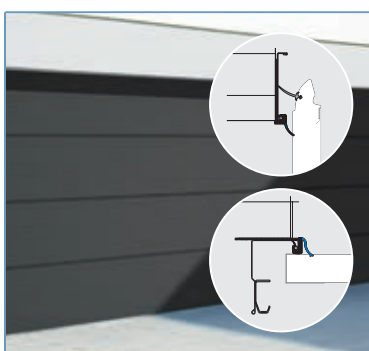

## Optional Thermo frame set

The optional sealing and insulating strip system further improves the already excellent performance of double-skinned DuraTherm sectional garage doors. The thermal optimisation on three sides of the frame enhances insulation performance by up to 15 %\* when mounted behind the opening. A plug-and-clip profile ensures quick and easy installation and can be used on all DuraTherm sectional doors. The Thermo frame set actively supports the optimisation of building performance.

\* Performance dependent on door pattern and size.



## High-quality, uniform appearance on the inside

Compared to other doors on the market, the Premium Plus sectional garage door is also much more attractive on the inside. The inside door surface is produced in the elegantly smooth finish.

And the door leaf, hinges and profiles are all in Traffic white, similar to RAL 9016, for uniform colouring and a harmonious overall look. Furthermore, high-quality, ball-bearing tandem rollers in stainless steel ensure extremely smooth and even door travel.

# DuraTherm 70 Door Patterns

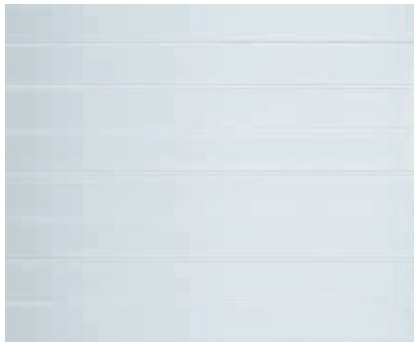

M-Rib

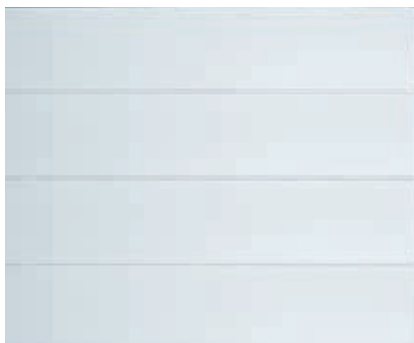

L-Rib

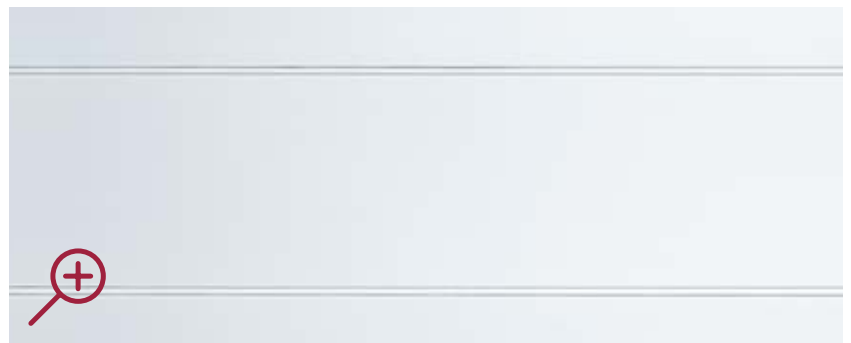
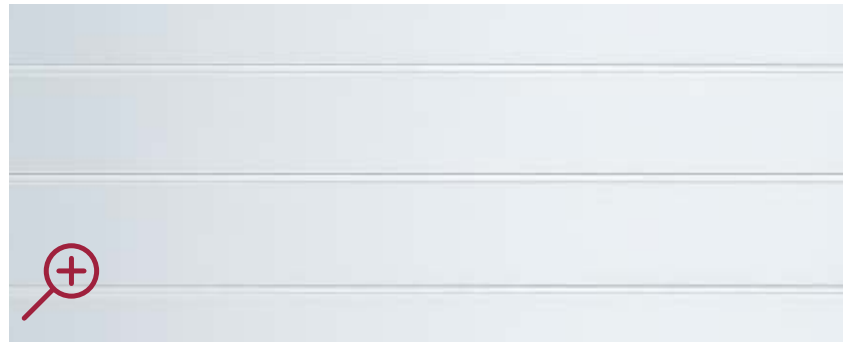

Illustrations show garage door leaf size 2,500 x 2,125 mm. Other garage door sizes can deviate from the illustration shown.

# Surfaces Finishes, Colours & Door Patterns For Single Garages

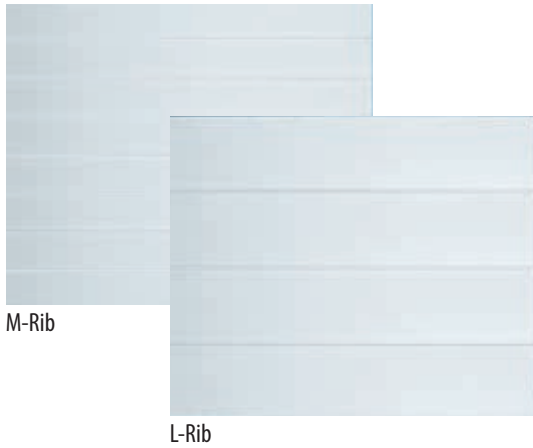

## Surface Finish



Smooth  
M-L Rib models only available in smooth texture.

## Standard Colour



Traffic White  
Similar to RAL 9016



For window & handle options, see **page 25!**

## Trend Colours:

|                                       |  |                                    |                                   |                                    |  |
|---------------------------------------|--|------------------------------------|-----------------------------------|------------------------------------|--|
|                                       |  |                                    |                                   |                                    |  |
| Steel Blue<br>Similar to RAL 5011     | Moss Green<br>Similar to RAL 6005      | Fir Green<br>Similar to RAL 6009   | Light Grey<br>Similar to RAL 7035 | Window Grey<br>Similar to RAL 7040 | White Aluminium<br>Similar to RAL 9006 |
|                                       |  |                                    |                                   |                                    |  |
| Grey Aluminium<br>Similar to RAL 9007 | Anthracite Grey<br>Similar to RAL 7016 | Ochre Brown<br>Similar to RAL 8001 | Nut Brown<br>Similar to RAL 8011  | Sepia Brown<br>Similar to RAL 8014 |  |

## RAL Colours

Can't find the colour you want? The DuraTherm 70 is also available in MOST Classic (4-digit) RAL for a modest price.

## Wood Effects (smooth):

|            |          |             |            |
|------------|----------|-------------|------------|
|            |          |             |            |
| Golden Oak | Dark Oak | Winchester* | Night Oak* |

## Satingrain Surface Finish:

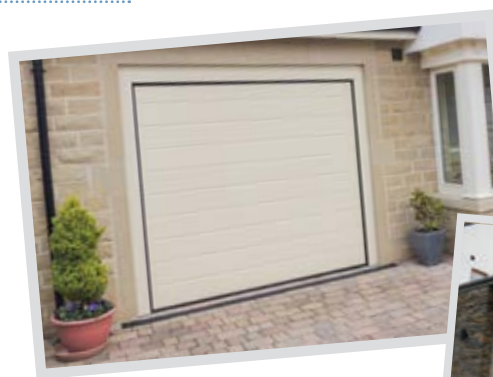

DuraTherm 70 M-Rib Smooth in Custom RAL Colour Cream



DuraTherm 70 L-Rib Smooth in Grey Aluminium (Similar to RAL 9007)

Colours shown are for guide purposes only and are limited by the printing process. Always request to see a finish sample for confirmation of colour.

RAL numbers are provided as the nearest approximation to the colour and will not match precisely.

# Key Features of DuraTherm 70

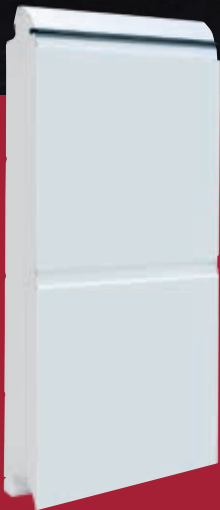

70 mm

DuraTherm 70 is filled with a rigid foam core, which provides particularly high heat insulation and excellent soundproofing.

- Ideal for private garages from 2,250 to 5,500 mm wide.
- Huge range of models and equipment:
  - As a design door on its own.
  - With a side door in the same design.
- Smooth running, superbly durable and stable thanks to a sturdy design that is extremely distortion resistant.
- Spring technology either with a vertical tension spring system or with stable torsion springs.
- Perfect functional reliability and easy operation with torsion spring with a spring fracture safety device on both sides.
- Maximum personal safety with anti-pinch protection inside and out (as per EN 12604).
- Particularly good heat insulation with 67 mm rigid PUR foam core (heat insulation value  $K = 0.34 \text{ W/m}^2\text{K}$ ).
- Inside door leaf: Polyester based primer, Traffic white, similar to RAL 9016.
- Outside door leaf (standard): Traffic white, similar to RAL 9016 (base coated).
- Outside door leaf: Trend Colour colours, RAL of your choice, Satingrain Black or wood effect for an additional charge (top coated). See model specific details **page 23**.



Our DuraTherm 70 sectional garage doors are available either with a vertical extension spring system or with stable torsion springs with a maintenance-free spring fracture safety device tested to EN 12604 (size/model dependant).



# DuraTherm 70 Options

## Windows



Standard Window



Cross Bar Pattern



Rhombus Pattern

Dimensions:

- Inside: approx. 392 x 192 mm
- Outside: approx. 460 x 260 mm

Window thicknesses:

- 16 mm double acrylic glazing, transparent or crystal

## Porthole windows \*Only available for M and L-Rib.



Porthole with stainless steel frame, 10 mm acrylic double glazing\*

Dimensions:

- Inside: approx.  $\varnothing$  290 mm
- Outside: approx.  $\varnothing$  350 mm



Steel painted RAL 9006 (White Aluminium)\*

Dimensions:

- Inside: approx. 235 x 235 mm
- Outside: approx. 320 x 320 mm

## Door handles



Plastic Handle, Black (Optional)

Optional lock handle for manual doors only is formed from a sturdy black polymer and supplied with a smooth operating Euro cylinder.



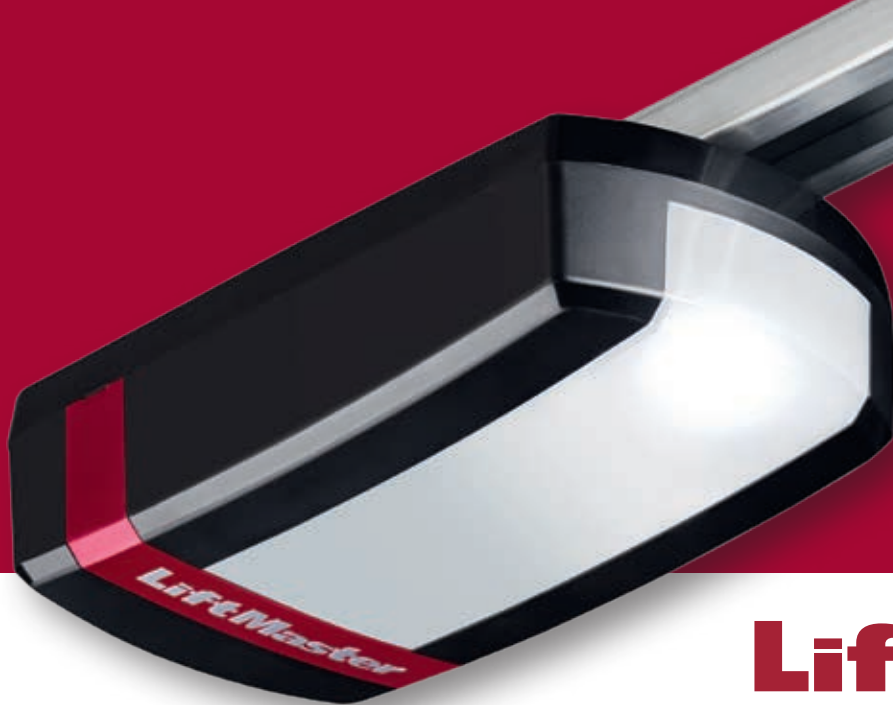

# LiftMaster®

MAKING LIFE EASIER

LM60 EVS

LM80 EVF

LM100 EVF

- Motor with built-in control unit and radio receiver.
- Remote controls (2x).
- Wireless wall station
- Belt drive rail.
- Installation kit.
- Installation and operation manual.



Wireless Wall Control 128EV

The LiftMaster® range of three openers covers force ranges from 650N to 1000N to provide optimum power for all sizes of Trend garage doors.



LM80 EVF & LM100 EVF - Two 4-button mini transmitters

## Accessories

### MyQ Kit

Internet Gateway 828EV plus 770E Protector System™

Revolutionary new accessory with built-in myQ® technology that connects to the internet and allows monitoring and operating the garage door opener in or around your home or from anywhere in the world by using a smartphone or a computer. It utilises a two-way communication system. Easy and fast installation through in-home router. No annual activation fee.

### Wireless Keypad 747EV

Open or close your garage door without using a remote control or key. The LiftMaster Wireless Keyless Entry System can open the door using a private 4-digit code. Allows temporary access codes for visitors. Completely wireless, powered by one 9-volt battery (included). Weatherproof flip-up protective cover. Backlit keypad makes numbers easy to see, even in the dark.



# Effortless Smart Control

Smart  
Touch



## The world's No.1

As a leading provider of convenience and security products for homes & businesses worldwide, LiftMaster's strong foundation emanates from the millions of products manufactured and sold since the early 1960s. Around the world, there are more LiftMaster openers installed than any other brand.

LiftMaster® extends the capabilities of garage door automation technology into smart control by phone, tablet or PC.

Feature  
File



### MyQ works with nest by Google

LiftMaster's myQ® technology is the first garage door control system to be integrated with the Nest platform. The optional myQ® system allows you to set your Nest Learning Thermostat or Nest Cam using the myQ® app. You can also move seamlessly between apps allowing you to open or close your garage door from anywhere you can access the internet ...and watch it all happen if you set up a Nest Cam in your garage.



### Permanent lighting

Long lasting LEDs (up to 50,000 hours of service), no warm up phase, so the light is bright immediately. Significantly lower CO2 emissions and no heavy metal or mercury in the production process.



### Warranty

We have also increased the warranty period up to a maximum of 7 years (LM100EV) to demonstrate that LiftMaster provides premium quality products.



### Sustainability

The low standby power consumption corresponds to savings of up to £230 over the life of the opener compared to the majority of garage door openers that are installed around the world.



### Pulling power

The EVS range includes some of the most powerful openers on the market handling door weights up to a massive 130 Kg and 5.5m wide.



### Speed

We have accelerated the speed of our operators to a maximum travel speed of 200 mm/sec for the LM80 and LM100 without having to pay a premium for this important distinguishing feature.



### Evolution Radio

Evolution garage door openers are equipped with the best radio performance ever with bi-directional radio – which means your garage door opener does not only receive signals, but also sends signals back.



### Whisper Quiet

The quiet and smooth operation provided by the belt drive system is second to none – try it out!

# Technical Information

## Side Extension Springs

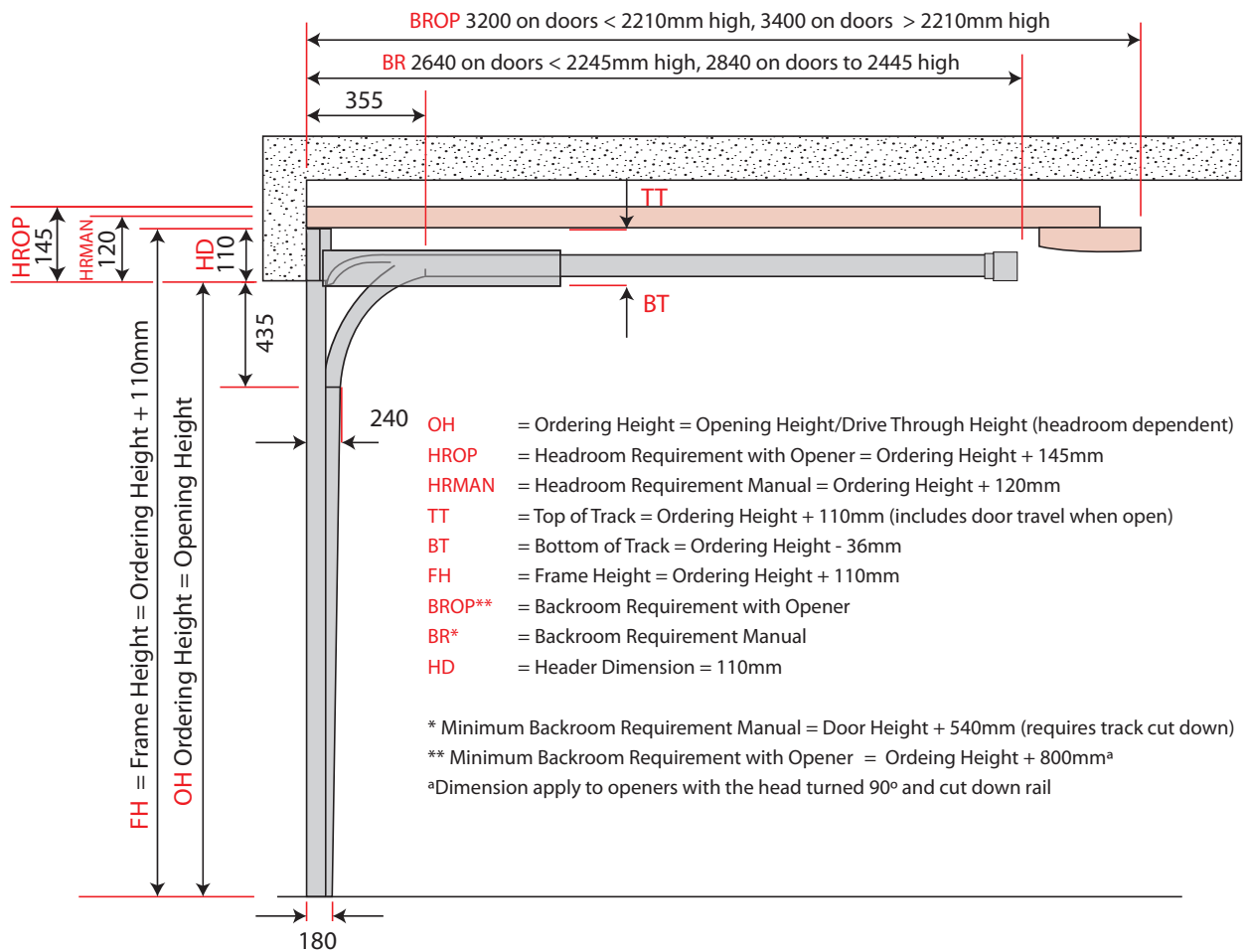

\* Minimum Backroom Requirement Manual = Door Height + 540mm (requires track cut down)  
 \*\* Minimum Backroom Requirement with Opener = Ordering Height + 800mm<sup>a</sup>  
<sup>a</sup>Dimension apply to openers with the head turned 90° and cut down rail

### Behind Reveal Fix

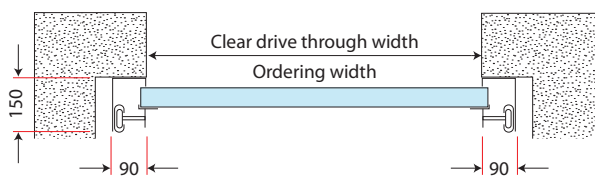

### Part Within Reveal Fix

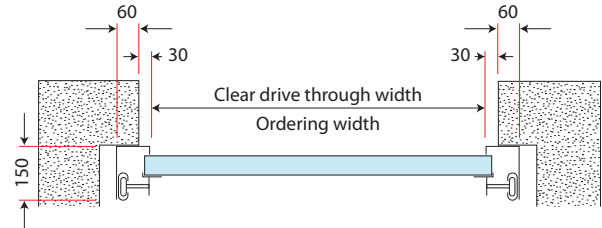

### Floor rebate

To help assist water draining away effectively from the door and prevent water ingress you must have a rebate (minimum

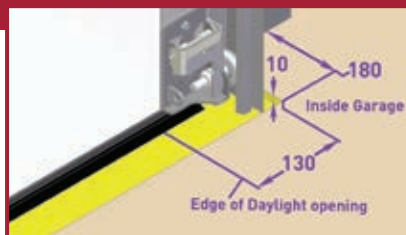

10mm) high behind the door threshold or where your door seal meets a level floor. If your floor is not rebated and not sloping away from the door you will be susceptible to water ingress as water will not be able to drain away effectively.

### Within Reveal Fix With Frame Covers

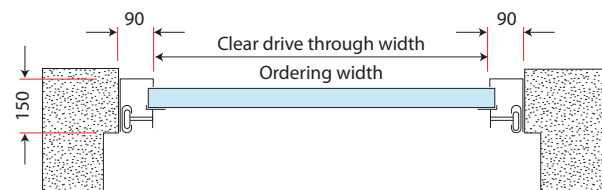

For "within the reveal fix" we recommend a minimum of 5mm fitting clearance each side, 10mm in total for brickwork coursing tolerance. For the door ordering size deduct 190mm from the narrowest point of the opening width. We also recommend an allowance of an additional 10mm clearance in height (subject to site conditions).

## Rear Mount Torsion Springs

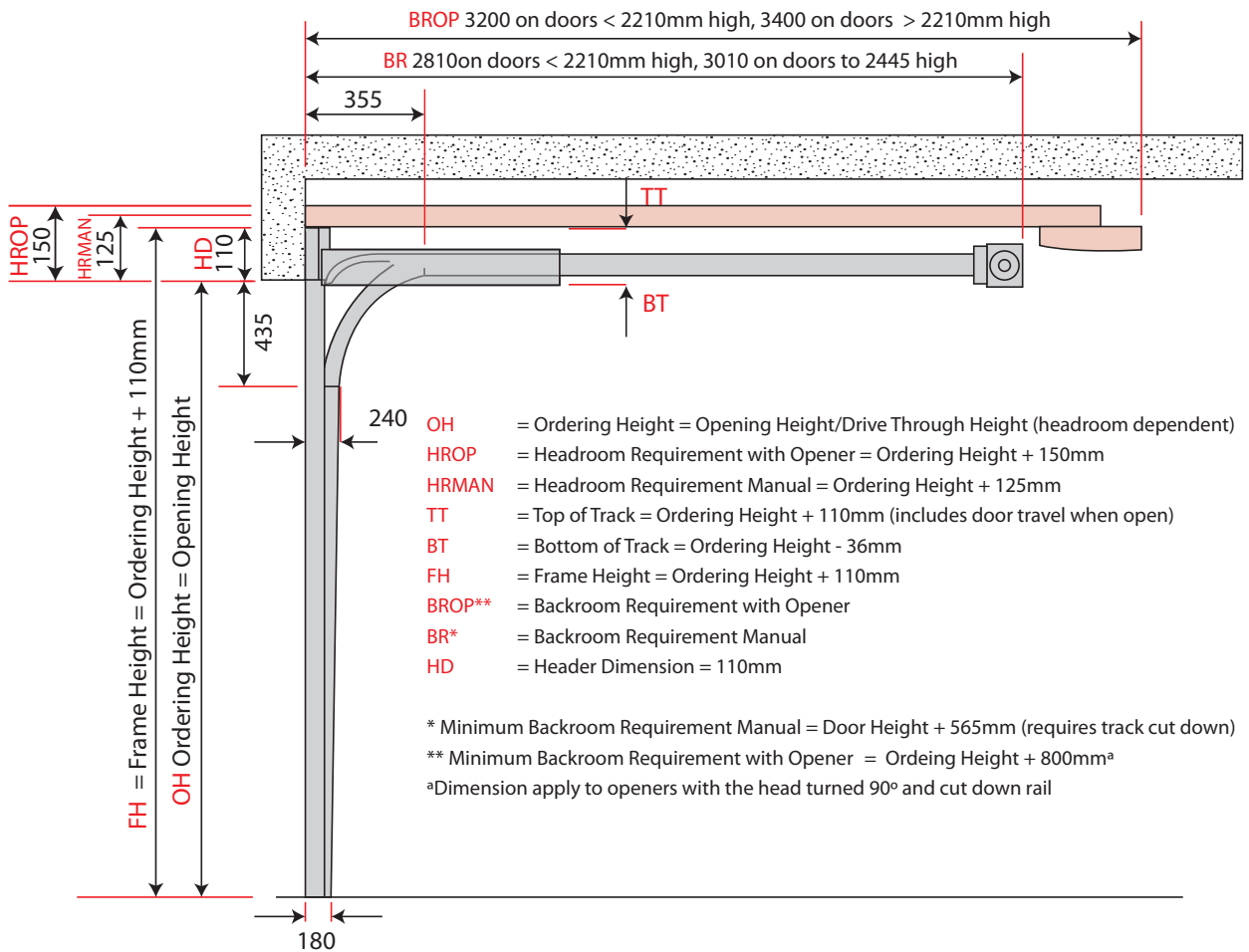

### Behind Reveal Fix

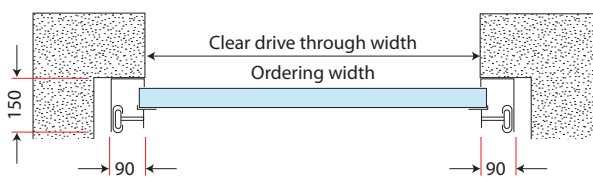

### Part Within Reveal Fix

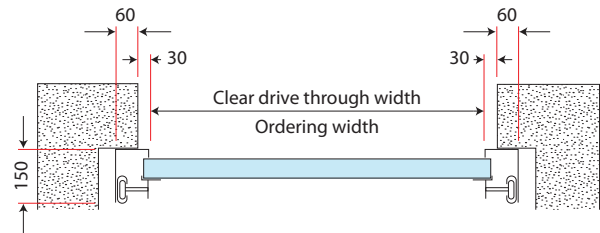

### Floor rebate

To help assist water draining away effectively from the door and prevent water ingress you must have a rebate (minimum 10mm) high behind the door threshold or where your door seal meets a level floor. If your floor is not rebated and not sloping away from the door you will be susceptible to water ingress as water will not be able to drain away effectively.

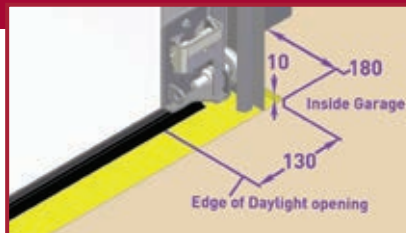

### Within Reveal Fix

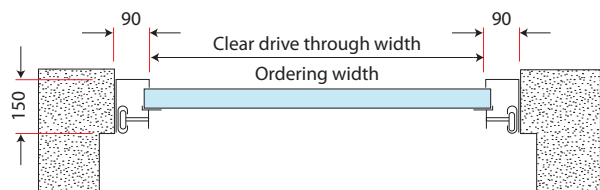

For "within the reveal fix" we recommend a minimum of 5mm fitting clearance each side, 10mm in total for brickwork coursing tolerance. For the door ordering size deduct 190mm from the narrowest point of the opening width. We also recommend an allowance of an additional 10mm clearance in height (subject to site conditions).

# Technical Information

## Front Mount Torsion Springs

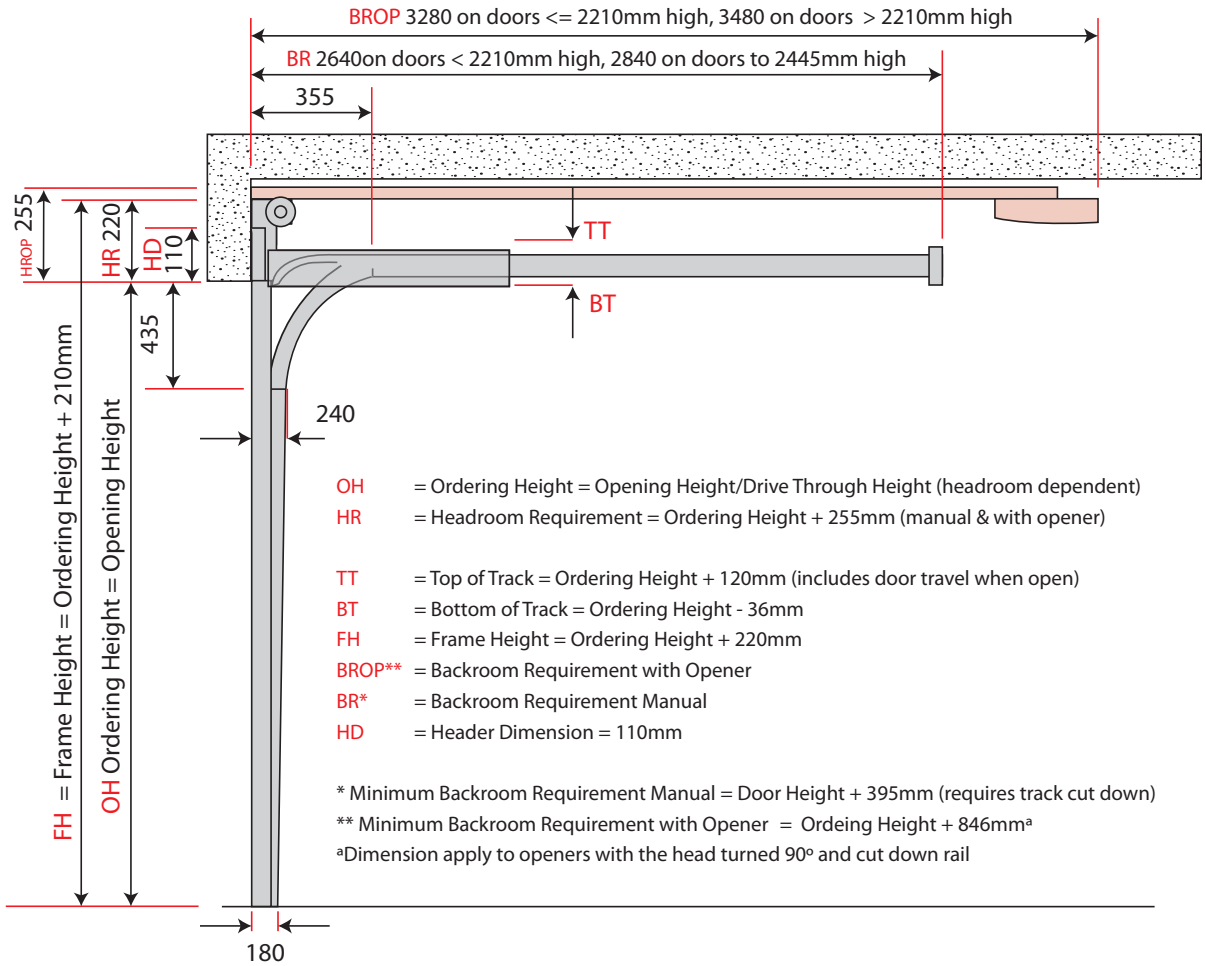

### Behind Reveal Fix

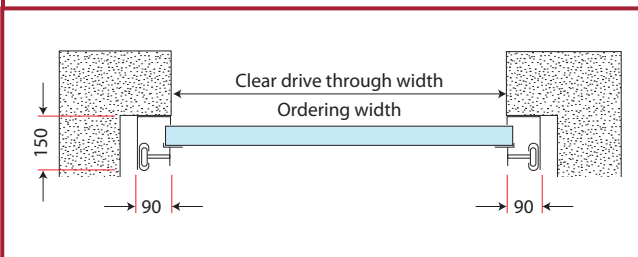

### Part Within Reveal Fix

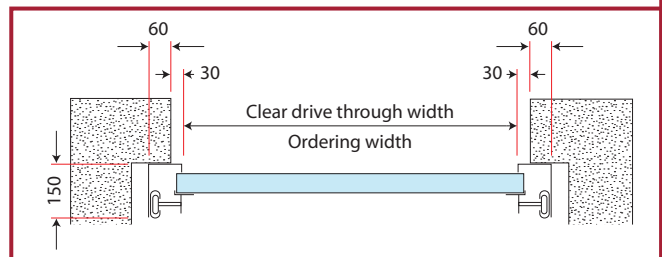

## Floor rebate

To help assist water draining away effectively from the door and prevent water ingress you must have a rebate (minimum 10mm) high behind the door threshold or where your door seal meets a level floor. If your floor is not rebated and not sloping away from the door you will be susceptible to water ingress as water will not be able to drain away effectively.

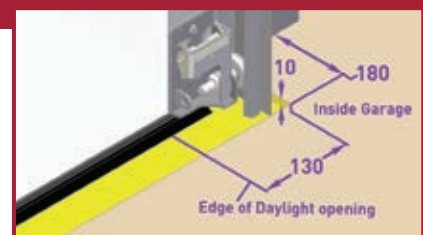

# The best performance for your door

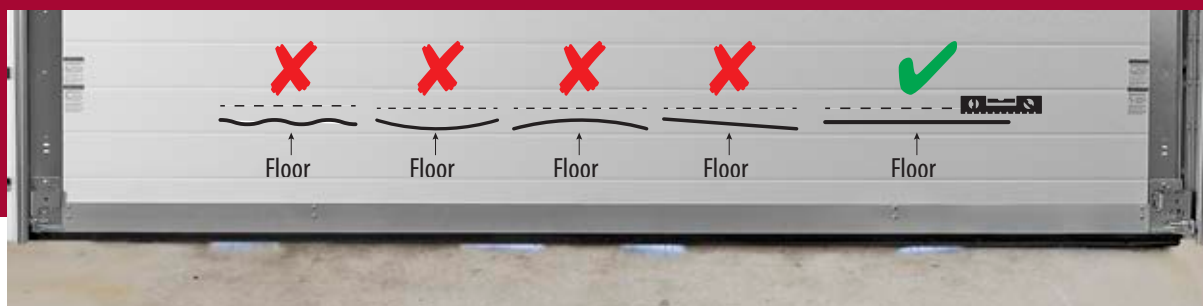

Sectional door provides the most effective sealing of any garage door design, however this is dependent on the installation environment:

## Floor Level

Should the leading edge of your garage door or side door not meet an even level surface you will experience gaps at points across the span of your garage opening when the door is closed. The image above shows gaps resulting from an uneven threshold.

To help assist water draining away effectively from the face of your door and prevent water ingress you must have a rebate (minimum 10mm) high behind the door threshold or where your door seal meets a level floor. If your floor is not rebated and not sloping away from the face of your door you will be susceptible to water ingress as water will not be able to drain away effectively.

Your Garage Door Systems professional installer will provide you with solutions to best overcome this.

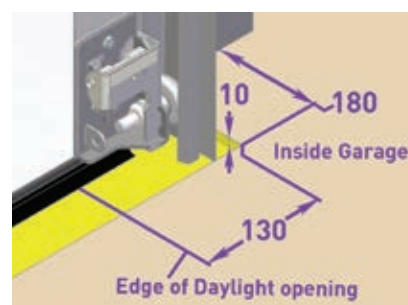

Allow for a floor rebate behind a level floor opening for improved weather protection

## How to clean and care for your door and its finish

Keeping your door looking its best doesn't require a great deal of time and requires no special skills! **Please refer to your customer care booklet, which will be supplied with your door, for details.**

All Garage Door Systems garage doors and operators are manufactured according to the strict quality management system iso 9001.

- All sectional garage door systems meet the high safety requirements of the European garage doors standard EN 13241.
- All Garage Door Systems garage doors and operators are tested by recognized institutes both individually and in combination.
- At Garage Door Systems, all garage door operators are tested in combination with all Garage Door Systems garage doors, and comply with current standards and rulings, thus eliminating the possibility of incorrect application.
- TÜV-tested burglar resistance\*: The German industry association for garage doors, doors and frames (Industrieverband Tore Türen Zargen) has drawn up a guideline that defines burglar resistance based on the existing standards. TÜV NORD CERT GmbH tests and certifies the garage doors: Garage Door Systems' certified garage doors guarantee the highest levels of safety tested by an impartial organisation.

10 year warranty for all steel sectional garage doors on functional reliability and against rusting from the inside out, with our seal of quality, 5 year warranty on top coated colours and surface finishes, wearing parts, and all mechanical, motor and motor control components of our garage door operators.

## Service & Maintenance

Trend garage doors are durable and very robust however regular servicing is required to ensure the safe and reliable operation of your garage door... often the largest moving object in the home. It is also a requirement of the doors warranty terms. Full detail of the warranty can be found at [www.garagedoorsystems.co.uk](http://www.garagedoorsystems.co.uk).

If in doubt about service and maintenance, always consult with your Garage Door Systems Installer who will be able to offer you a regular maintenance service for your garage door.





...& good night!

# Great to come home to!

[www.garagedoorsystems.co.uk](http://www.garagedoorsystems.co.uk)



Garage Door Systems Limited,  
Wakehurst Ind. Est., Ballymena, BT42 3AZ

NI: Tel: 028 2565 5555 Fax: 028 2564 4030  
RoI Tel: 1850 510 510 Fax: 028 2564 4030  
UK Tel: 0870 242 3 242 Fax: 0800 085 2741  
Email: [info@garagedoorsystems.co.uk](mailto:info@garagedoorsystems.co.uk)

Authorised Specialist

Garage Door Systems operates a policy of continuous product development and reserves the right to alter specifications to product design features, product functionality, other product specifications and product manufacture without notification. All specifications are correct at time of publication, errors and omissions excepted. Date 07/22 Issue 1. Colours shown are for guide purposes only and are limited by the printing process.

DuraThermSE 07/22